

tyco | Illustra

Illustra Standard E Series

Dome Camera

Quick Start Guide

ISE-V05F284-N ISE-V05F283S-N
ISE-V05F364-N ISE-V05F363S-N
ISE-V04F284-N ISE-V04F283S-N
ISE-V04F364-N ISE-V04F363S-N

- Please read this instruction carefully for correct use of the product and keep it for further reference.
- All the examples and pictures used here are for reference only.
- The contents of this manual are subject to change without notice.

1 Warning and Caution

- If the product does not work properly, please contact your dealer or the nearest service center. Never attempt to disassemble the camera yourself. (We shall not be responsible for any problems caused by unauthorized repair or maintenance.)
- Do not allow water or liquid intrusion into the camera.
- In the use of the product, you must be strict compliance with the electrical safety regulations of the nation and region. When the product is mounted on wall or ceiling, the device shall be firmly fixed.
- Do not use camera beyond specified voltage range.
- Do not drop the camera or subject it to physical shock.
- Avoid touching the camera lens.
- If cleaning is necessary, please use clean cloth to wipe it gently. If the device will not be used for a long time, please cover the lens cap to protect the device from dirt.
- Do not aim the camera at the sun or extra bright place.
- Do not place the camera in extremely hot, cold (the operating temperature shall be -30°C~60°C), dusty or damp locations, and do not expose it to high electromagnetic radiation.
- To avoid heat accumulation, good ventilation is required for operating environment.

2 Package

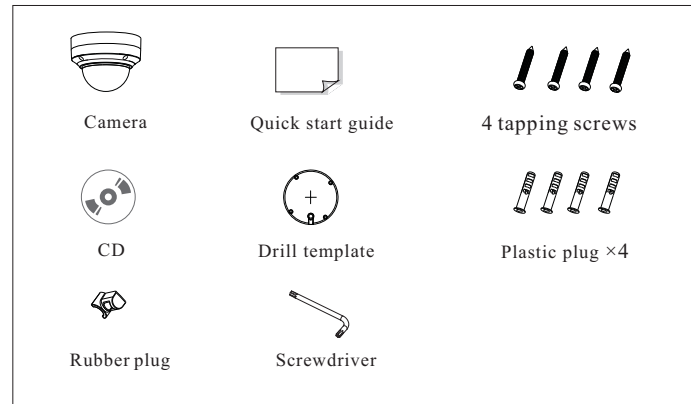

3 Overview

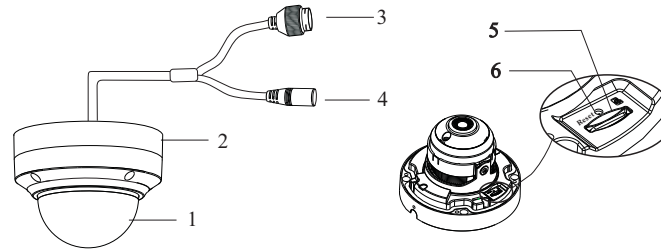

1	Lower dome	4	Power connector
2	Mounting base	5	Micro SD card slot
3	Network connector	6	Reset

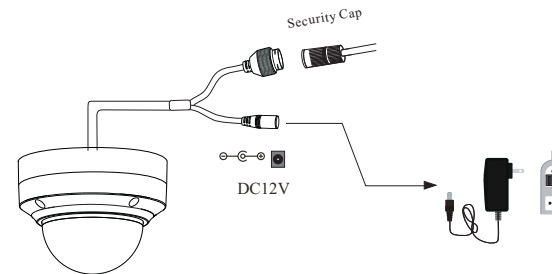

- * 1 It is recommended to install the security cap for outdoor installation.
- * 2 If the PoE switch is used to power the camera that supports PoE power supply, DC12V power supply is not required.

▶ Connecting Network Cable

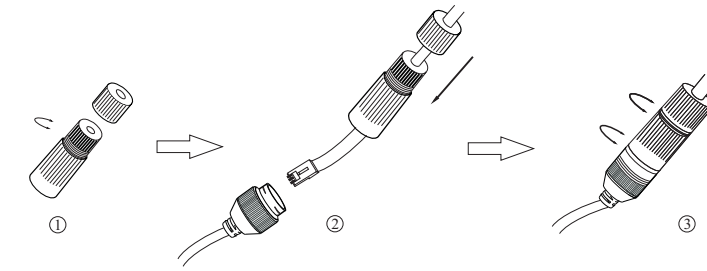

- ① Loosen the nut from the main element.
- ② Run the network cable (without RJ 45 connector) through the both elements. Then crimp the cable with RJ 45 connector.
- ③ Connect the cable to the hermetic connector. Then tighten the nut and the main cover.

4 Installation

- * Please make sure that the wall or ceiling is strong enough to withstand 3 times the weight of the camera.
- * Please install the camera in the dry environment. You'd better install back the lower dome less than 4 hours after removing it.
- * Do not directly touch the dome when installing.
- * Do not remove the protection film until finishing the installation.

- ① Attach the drill template to the place where you want to fix the camera and then drill the screw holes and the cable hole on the wall according to the drill template.

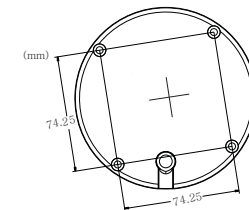

- ② Loosen the screws to remove the lower dome from the camera.

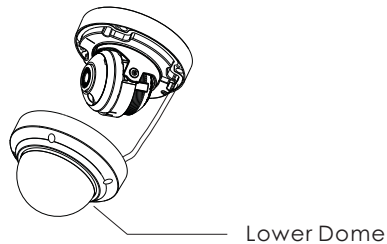

③ Route and connect the cables.

④ Secure the mounting base with camera to the wall with screws as shown below.

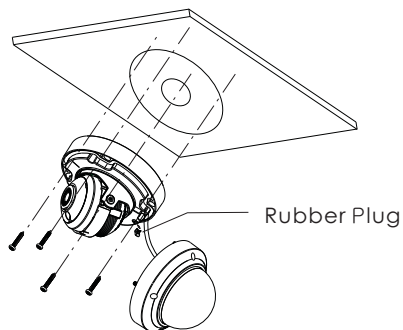

⑤ Three-axis adjustment. Before adjustment, preview the image of the camera on a monitor and then adjust the camera according to the figure below to get an optimum angle.

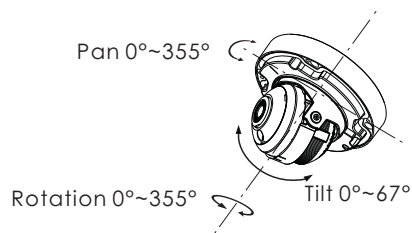

⑥ Install the lower dome back to the camera and secure it with the screws. Then remove the protection film to finish the installation.

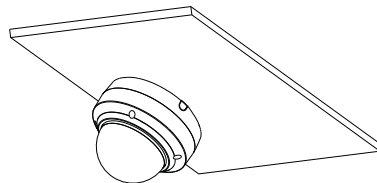

5 Network Connection

● Access the camera through TycoIPTool

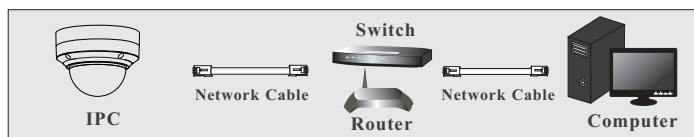

① Make sure that the camera and the PC are well connected to the LAN.

② Find the TycoIPTool from the CD and then install it in the computer. After that, run the TycoIPTool as shown below.

Device Name	Device Type	Product Model	IP Address	Http Port	Data Port	Subnet	Modify Network Parameter
name	IPC	unknown	192.168.1.168	80	9008	255.255	Mac Address: CE:98:23:75:35:22
name	IPC	unknown	192.168.1.2	80	9008	255.255	IP Address: 192.168.1.168
name	IPC	unknown	192.168.1.3	80	9008	255.255	Subnet Mask: 255.255.255.0
							Gateway: 192.168.1.1

Tip: Enter the administrator password, and then modify the network parameters.

Restore IPC Default Configuration

Total Device: 3 Local IP Address: 192.168.1.4 Subnet Mask: 255.255.255.0 Gateway: 192.168.1.1 DNS : 210.21.196.6

③ Modify the IP address. The default IP address of this camera is 192.168.1.168. Click the information of the camera listed in the above table to show the network information on the right hand. Modify the IP address and gateway of the camera and make sure its network address is in the same local network segment as that of the computer. Please modify the IP address of your device according to the practical situation.

Modify Network Parameter ▲

Mac Address:

IP Address:

Subnet Mask:

Gateway:

Tip: Enter the administrator password, and then modify the network parameters.

For example, the IP address of your computer is 192.168.1.4. So the IP address of the camera shall be changed to 192.168.1.X and the gateway shall be changed to 192.168.1.1. After modification, please enter the password of the administrator and click “Modify” button to modify the settings.

⚠ The default password of the administrator is “*admin*”.

④ Double-click the camera listed in the IP-Tool or manually enter the IP address in the address bar of the web browser to connect IP-CAM. Then follow directions to download and install the plugin.

⑤ Enter the username and password in the login interface.

⚠ The default username is *admin*; the default password is *admin*.

Tips

Transparent Dome Maintenance

Transparent dome is an optical element. As dirt, dust or fingerprints on the dome will reduce the clarity of the image, please don't touch or wipe the cover surface directly during installation and use. Please refer to the following cleaning tips to clean it.

- * If there is dust on the dome, please use a dry soft brush to gently brush it.
- * If there is water or grease on the dome, please gently wipe off the water drop or grease with a soft cloth and then use oil-free cotton cloth with the neutral detergent to wipe it several times from the center to outward. Finally, change the cloth to dry it.
- * If there are fingerprints on the dome, please use oil-free cotton cloth or paper soaked with the neutral detergent to wipe it several times from the center to outward and then dry it with a soft cloth.