

Pro Gen4

Outdoor 2MP & 8MP (4K) PTZ



Key Features

- AI Object classification combined with event rules to pinpoint forensic searches or trigger events
- Large zoom capacity to identify important features at a greater distance
- Rain dispersion for a clear image
- Auto-tracking based upon face or person detection
- Image stabilisation for clarity of image at large zoom setting
- True Day/Night and an IR distance up to 200M
- Encrypted, end to end, video streaming for protection of video

Maintain Control and Detail with a Responsive, Accurate PTZ

The exceptional speed and silence of the Illustra Pro PTZ coupled with ultra-low latency performance gives security personnel the ability to accurately track subjects in mission critical applications. The camera employs zoom-adjusted program technology to automatically control the pan and tilt speed in proportion to the amount of zoom used, delivering precise pan and tilt control. Using programmed presets and tours, the Illustra Pro PTZ moves into position at up to 700° per second.

Safeguard Against Cyber Attacks Across Devices

Illustra Pro Cameras have been designed to be resilient against cyber-threats. Our products are gated, analysed, tested and required to meet or exceed the rigorous standards of the Johnson Controls Cyber Solutions Product Security Program for every consecutive release. This holistic approach is aimed at providing peace of mind to our customers. Our security mindset begins at initial design concept and is supported through deployment, including a rapid incident response to meet the comprehensive and evolving cybersecurity environments.

Achieve Clarity Despite Challenging Scene and Lighting Conditions

The Illustra Pro Gen 4 PTZ is designed to provide a suite of benefits to enable operators to benefit from better situational awareness and to respond more quickly to potential threats or situations. Leveraging the latest chip technology, the camera has inbuilt Automated Intelligent (AI) analytics such as person and object identification which also can be used for automated tracking.

Specifications





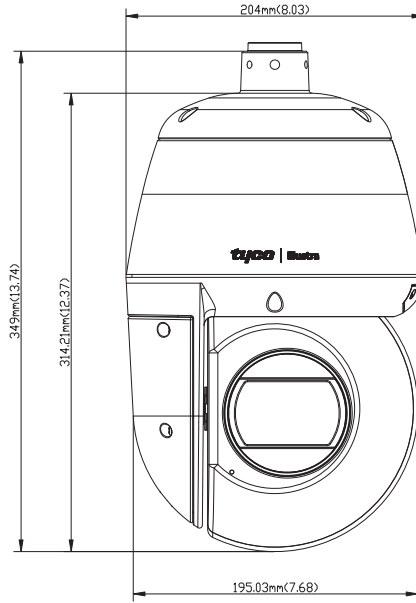

Operational	2MP	8MP (4K)
Imager	Sony 1/2.8" CMOS Imager	Sony 1/1.8" CMOS Imager
Video Compression	H.264 / H.265 / MJPEG / IntelliZip	
Configurable Streams	Quad Streaming	
Max Frame Rate	2MP@60fps	8MP@30fps/ 2MP@60fps
Resolution & Aspect Ratio	1920 x 1080, 1664 x 936, 1280 x 720 1024 x 576, 960 x 544, 816 x 464 640 x 360, 480 x 272, 640 x 368	3840 x 2160, 3264 x 1840, 2688 x 1520 1920 x 1080, 1664 x 936, 1280 x 720 1024 x 576, 960 x 544, 816 x 464 640 x 360, 480 x 272, 640 x 368
Bitrate Control	CBR, VBR, CVBR	
Lens Type	Zoom Lens, DC-Iris, IR Corrected	
Image Stabilisation	Optical Image Stabilisation	Electronic Image Stabilisation (Future firmware)
Focus Control	Continuous, Auto Focus, Manual Focus	
Aperture	F/1.8(W) ~ F/6.5(T)	F/1.5(W) ~ F/3.4(T)
Minimum Illumination Color	0.015 lux	0.06 lux
Minimum Illumination BW	0.0035 lux	0.015 lux
Wide Dynamic Range	True multi-shutter WDR 126dB, Off / Smart WDR / True WDR 2x / True WDR 3x	
Noise Reduction	Digital Noise Reduction 2D and 3D	
Day/Night	TDN CF removal	
IR Illuminator / Distance	Up to 200 m (656 ft), Smart IR, Adaptive IR	Up to 150 m (492 ft), Smart IR, Adaptive IR
Picture Settings	Auto Exposure: Multiple Profiles (incl Auto, Gaming, LPR), Multiple ROI (incl AI ROI: Object, Person, Face), Gain Control (Auto, Max, Manual), Flickerless White Balance: Auto Normal, Auto Wide, Manual	
Shutter Speed	≥ 1/10,000 to 1/4 s	
Smart Defog	Supported	
Privacy Zones	10	
Shake and Dry	Supported	
ONVIF Conformance	Profile S, G, M, T	
Alarm Input/Output	2/2	
Audio	G.711, Bi-directional; 1 input, 1 output	
PTZ Operational		
Optical Zoom	42x Optical Zoom, 12x Digital	22x Optical Zoom, 12x Digital
Focal Length Range	7-295 mm	6-139 mm
Field of View (H/V)	Wide Angle: 43°/24° Telephoto: 1.6°/0.9°	Wide Angle: 61.9°/36.2° Telephoto: 3.4°/1.7°
Pan Travel	360° Continuous	
Tilt Travel	+15° to -90°	
Manual Continuous Speed	< 0.25° to 100°/s scaled in proportion to zoom position	
Preset Accuracy	< 0.1 degree	
Preset Speed	700°/sec (Typical: 465°/sec), 0.5sec Move Time	
Presets	300	
Sequences	96	
Pattern	16	
Home Function	Yes	
Auto Flip	Yes	



Analytics	
AI Face Detection	Supported
AI Object Classification	Classes: Person, Bicycle, Bus, Car, Motorbike, Train, Truck, Cart, Backpack, Handbag, Suitcase, Any Class
	Rules: Object Detected, Perimeter, Linger, Dwell, Abandoned/Removed, Enter, Exit, Crowd, Queue
	Sub-classes: Person Clothing Color, Vehicle Color
AI Tamper Detection	Blackout, Whiteout, Scene Change (FoV tamper)
AI Blur Detection	Supported
AI Metadata	Supported
AI Object Tracking	Face, Person (including Intelligent guard tour)
Motion Detection	Supported
Network	
Ethernet Interface	IEEE 802.3, 10/100/1000Base-T Ethernet, RJ45, auto sensing
Supported Protocols	TCP/IP, IPv4, IPv6, TCP, UDP, HTTP, FTP, DHCP, WS-Discovery, DNS, DDNS, RTP, RTCP, RTSP, TLS, Unicast (10 users), Multicast (unlimited users), NTP, ICMP, IGMP, SMTP, WS-Security, IEEE 802.1x, PEAP, EAP-TLS, EAPoL, SSH, HTTPS, SOAP, WSAddressing, CIFS, SNMP, UPNP™, RTSP, LLDP
Encrypted Video Streaming	Yes via HTTPS
Configuration Management	
Web Browser	IE 10, 11, Firefox, Chrome
Security	Secure Boot, Enhanced Security Mode (forces complex passwords, HTTPS and disables discovery); TLS 1.2 (256 bit cipher minimum); Security Overview Page (status and configuration); RTSP Authentication; IEEE 802.1X Client; Remote Accessible Audit logs; Role-Based Access Control and SD card encryption
Onboard Storage	
Card Support	Built-in Micro SDXC slot up to 2TB per slot; Card not included
Pre-Alarm Recording	Yes
Recording Format	mp4
Encrypted Storage	Yes
Recording Trigger	Dry Contact Alarms, Motion Detection, Face Detection, Video Intelligence , AI Object Classification, Periodic Events
TrickleStor	Yes, encrypted storage
Electrical	
Power Input	802.3bt Type 4 (90W), PoE BT Injector IA-POE-90-U00 recommended
Voltage	22 to 30 VAC, Class 2 LP 72W
Surge Protection	6KV contact 8KV air
Physical	
Dimensions (RxHxW)	Ø8.03 x 13.74 in (Ø204 x 349 mm)
Weight	7kg (15.4 lbs.) Shipping Weight 9.8 kg (21.6 lbs)
Housing Color	RAL 9003 - Signal White
Operating Temperature	-58°F to 140°F (-50°C to +65°C), 1 x Fan, 1 x Heater
Storage Temperature	-40°F to 149°F (-40°C to +65°C)
Humidity	Up to 95% RH Non-Condensing
Vandal Resistant	IK10
Outdoor Rating	IP66
Analogue out	2-pin analog video out service port
Regulatory	
Emissions	FCC Part 15 Class A; CE EN55032 Class A; AS/NZS CISPR 32 Class A; ICES-003/NMB-003 Class A
Immunity	EN50130-4; EN61000-6-1
Safety	UL60950-1 /UL62368/UL60950-22; IEC 60950-1/62368/60950-22; CSA 22.2 No. 60950/62368; CE: EN60950-1 / EN62368 / EN60950-22; UL 50 (Type 4X); EN60529 (IP66/67)
Environment	RoHS; REACH; WEEE
NDAA & TAA Compliant	Yes
Warranty	5 Year Warranty

Outdoor Pro Gen4 PTZ



Accessories

Accessory Type	Image	Model Number	Description	Dimensions	Color
Wall Mount		RHOSW	Short wall mount with end cap. For use with RHOWPA pole strap adapter and RHOWCA corner bracket adapter	With Dome Installed 14 x 9 x 11 in (366 x 218 x 282 mm)	RAL 9003
Wall Mount		RHOLW	Long wall mount with end cap	With Dome Installed 14 x 9 x 23 in (366 x 218 x 587 mm)	RAL 9003
Over the Roof Mount		RHOTR	Affixes directly to vertical roof wall or parapet, positions dome away from wall	43 x 10 x 19 in (1098 x 243 x 473 mm)	RAL 9003
Over the Roof Floor Mount		ROTRF	Enables RHOTR over-the-roof mount to be installed on horizontal and vertical roof/parapet surfaces	15 x 10 x 10 in (369 x 240 x 240 mm)	RAL 9003
Corner Bracket Adapter		RHOWCA	Enables long and short wall mounts (RHOSW and RHOLW) to affix to outside corners	7 x 8 x 5 in (185 x 210 x 125 mm)	RAL 9003
Pole Strap Adapter		RHOWPA	Enables RHOSW and RHOLW to affix to poles	Straps Support: 5 x 3 x 1 in (138 x 79 x 27 mm) Pole Diameter: 2 to 38 in (53 to 951 mm)	RAL 9003

End Cap Assembly		ROENDC	Indoor/outdoor head adapter mount	3 x 4 x 8 in (64 x 103 x 194 mm)	RAL 9003
PoE Injector		IA-POE-90-U00	90W PoE Midspan, compatible with both the indoor and outdoor Pro 4 PTZ cameras. Comes with a US power lead	3.307 x 3.15 x 0.984 in (84 x 80 x 25 mm)	Black
PoE Injector		IA-POE-90-U00-EU	90W PoE Midspan, compatible with both the indoor and outdoor Pro 4 PTZ cameras. Comes with a UK & EU power lead	3.307 x 3.15 x 0.984 in (84 x 80 x 25 mm)	Black

Ordering Information

Model Numbers	Description
IPS02-P24-OI04	Illustra Pro Gen4 2MP PTZ, 42x, Edge AI, TDN w/IR, TWDR, Outdoor, Vandal, White
IPS08-P25-OI04	Illustra Pro Gen4 8MP (4K) PTZ, 22x, Edge AI, TDN w/IR, TWDR, Outdoor, Vandal, White

Accessories

Model Numbers	Description
Outdoor Mounting Options	
RHOSW	Short Wall Mount with End Cap
RHOLW	Long Wall Mount with End Cap
RHOTR	Over the Roof Mount
Outdoor Adapter Options	
ROTRF	Over the Roof Floor Mount
RHOWCA	Corner Bracket Adapter
RHOWPA	Pole Strap
ROENDC	End Cap Assembly
Power	
IA-POE-90-U00	95W PoE Injector
IA-POE-90-U00EU	95W PoE Injector EU (EMEA)

Specifications are subject to amendment without notification

About Johnson Controls

At Johnson Controls (NYSE:JCI), we transform the environments where people live, work, learn and play. As the global leader in smart, healthy and sustainable buildings, our mission is to reimagine the performance of buildings to serve people, places and the planet.

Building on a proud history of nearly 140 years of innovation, we deliver the blueprint of the future for industries such as healthcare, schools, data centers, airports, stadiums, manufacturing and beyond through OpenBlue, our comprehensive digital offering.

Today, with a global team of 100,000 experts in more than 150 countries, Johnson Controls offers the world's largest portfolio of building technology and software as well as service solutions from some of the most trusted names in the industry.

Visit www.johnsoncontrols.com for more information and follow [@JohnsonControls](https://twitter.com/JohnsonControls) on social platforms.

© 2023 Johnson Controls. All rights reserved. Product offerings and specifications are subject to change without notice.

Actual products may vary from photos. Not all products include all features. Availability varies by region; contact your sales representative

IL1419-DS-202309-R08-HS-EN