



# Illustra Pro 12MP Fisheye

## Quick Start Guide

## Notice

The information in this manual was current when published. The manufacturer reserves the right to revise and improve its products. All specifications are therefore subject to change without notice.

## Copyright

Under copyright laws, the contents of this manual may not be copied, photocopied, reproduced, translated or reduced to any electronic medium or machine-readable form, in whole or in part, without prior written consent of Tyco Security Products.

© 2017 Tyco Security Products. All Rights Reserved.

Tyco Security Products

6600 Congress Avenue

Boca Raton, FL 33487 U.S.A.

## Customer Service

Thank you for using Illustra products. We support our products through an extensive worldwide network of dealers. The dealer through whom you originally purchased this product is your point of contact if you need service or support. Our dealers are empowered to provide the very best in customer service and support. Dealers should contact Tyco Security Products at (800) 507-6268 or (561) 912-6259 or on the Web at [www.illustracameras.com](http://www.illustracameras.com).

## Trademarks

Windows® is a registered trademark of Microsoft Corporation. PS/2® is a registered trademark of International Business Machines Corporation.

The trademarks, logos, and service marks displayed on this document are registered in the United States [or other countries]. Any misuse of the trademarks is strictly prohibited and Tyco Security Products will aggressively enforce its intellectual property rights to the fullest extent of the law, including pursuit of criminal prosecution wherever necessary. All trademarks not owned by Tyco Security Products are the property of their respective owners, and are used with permission or allowed under applicable laws.

Product offerings and specifications are subject to change without notice. Actual products may vary from photos. Not all products include all features. Availability varies by region; contact your sales representative.

## License Information

Your use of this product is governed by certain terms and conditions.

### Notice of Use

- This manual is designed for administrators and users of the network camera. Please read it carefully before use. All requirements should be followed before using this camera.
- We are not responsible for any technical or typographical errors and reserve the right to change the product and manuals without notice.
- Keep this document for future reference.
- It is intended that this camera utilizes a PoE power source that complies with LPS requirements.
- The camera must be installed on a solid mounting surface.
- Keep the camera and other accessories dry.
- We are not responsible for any damage caused by inappropriate use.

**Safety Notice**

The recessed indoor camera models are rated as suitable for use in environmental air handling spaces, except inside air ducts or furnace plenums.

CAUTION: Risk of explosion if the battery is replaced by an incorrect type. Dispose of used batteries according to the instructions.

**ESD Precautions:**

With the covers removed during installation and alignment this product is sensitive to electrostatic discharge. The installer should take appropriate ESD control measures such as the use of a ESD wrist strap connected to the chassis of the camera.

**Note:**

---

PoE networks that are connected to IP Encoders should not be routed to the exterior or outside of the installed plant location.

---

# Contents

---

<b>Product Features</b> .....	<b>1</b>
Features .....	1
Dimensions .....	2
What's in the Box .....	3
<b>Mounting the Camera</b> .....	<b>4</b>
Mounting the Fisheye Camera .....	4
Cable Sealing .....	6
<b>Connecting the Camera</b> .....	<b>7</b>
<b>Powering the Camera</b> .....	<b>8</b>
Ethernet Cable Connection .....	8
<b>Desiccant Bag Installation</b> .....	<b>9</b>
<b>Accessing the Camera for the First Time</b> .....	<b>12</b>
Illustra Connect .....	12
Key functions of Illustra Connect .....	12
Discovering the Illustra Camera .....	13
Illustra Connect .....	13
Configuring the Illustra Camera using a Static IP Address .....	14
<b>Physical Reset of the Camera</b> .....	<b>15</b>
Resetting the Camera to Factory Default Settings Using the Reset Button .....	15
<b>Technical Specifications</b> .....	<b>16</b>
Technical Specifications .....	16
MJPEG/JPEG Compressor Key Functionality .....	16
H.264 Compressor Key Functionality .....	16
Resolution .....	17
Base Protocol and Underlying Layers .....	19
Network Access Configuration .....	19
Network Name Resolution .....	20
Email .....	20
Time Synchronization and Configuration .....	20
Authentication and Security .....	20

---

Firewall .....	20
Illustra API Version .....	21
Discovery .....	21
UPnP Discovery .....	21
ONVIF Video and Control Interface .....	22
Interface Technical Specifications .....	22
ONVIF Functions Supported .....	23
microSD Card .....	23
Environmental .....	23
Power .....	23
Regulatory Compliance .....	24
<b>Appendix A: Camera Defaults for Fisheye Camera .....</b>	<b>25</b>

## Features

- Mega pixel HD up to 12MP Resolution
- Supports three independently configurable streams
- Edge Dewarping,
- Three Stream Compression: Baseline / Main /H264 high only supported/ MJPEG
- Multiple Dewarping modes: Active Image (ePTZ) / Panorama View / Quad View / Combi
- Unicast and Multicast Streaming capability
- Motion detection analytics & metadata event generation
- Supports one Alarm in and one alarm Out
- Support for Events action on DIO & analytics
- Audio In and bidirectional Audio out support
- PoE powering capability
- Supports configuration of Privacy Zones
- Supports configuration of Presets, Scans and Sequences on Dewarped Active Images ePTZ
- Supports IPv4 which supports DHCP
- DynamicDNS
- Supports FTP, SMTP, SNMP, and CIF
- microSD Recording Support
- Enhanced security, https & 802.1 support
- Wide Dynamic Range
- Day / Night (ICR –infrared cutfilter removal)
- Smart Picture Quality / 3D Noise Reduction
- Weatherproof (IP66 International)
- ONVIF Support
- No plugin or third party dependencies

# Dimensions

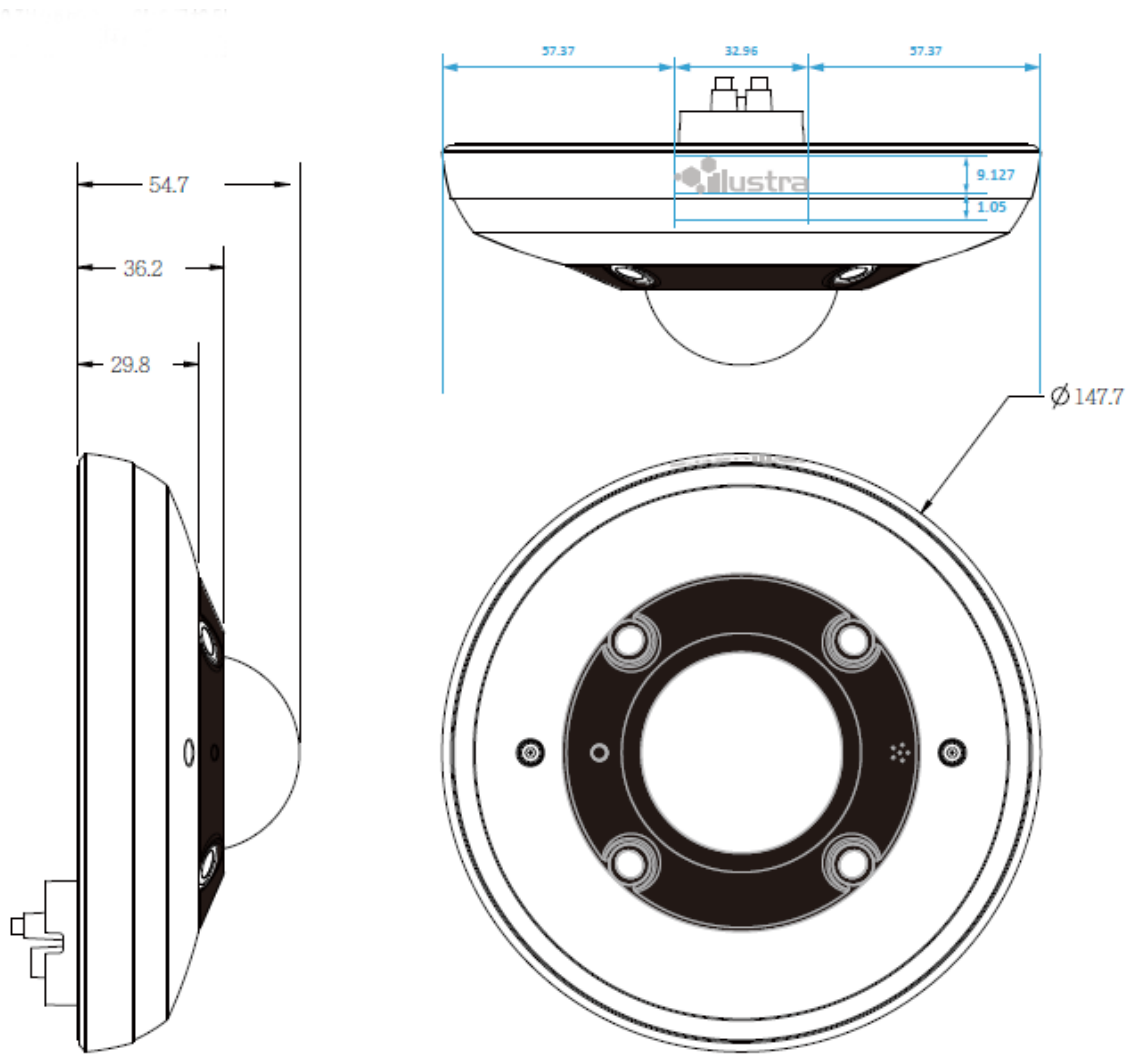
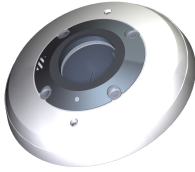

Figure 1 Fisheye Camera dimensions

## What's in the Box

Please check the box contains the items listed here. If any item is missing or has defects do not install or operate the product and contact the dealer for assistance.



Illustra Pro 12MP Fisheye Camera



Security Torx



Power Terminal Block

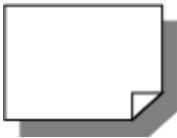

Quick Start Guide



CD containing User Manual and Illustra Connect discovery tool



Plastic Anchor (x3)



Cable Seal



Standoff Ring



Adaptor plate



Desiccant Bag

### Figure 2 Package Contents

The package should also contain the following items:

M3 Standard screw with washer (x6), M3 Standard Screw without washer (x3), 2500-0053-01 O-ring (x1), 3200-0456-01 3M tape (12cm/5") (x1), Standoff ring (x1), Regulatory document (x1).



# Mounting the Camera

Select the type of mounting required and refer to the relevant procedure.

Use the mounting template provided below to guide you where to drill the holes.

## Mounting the Fisheye Camera

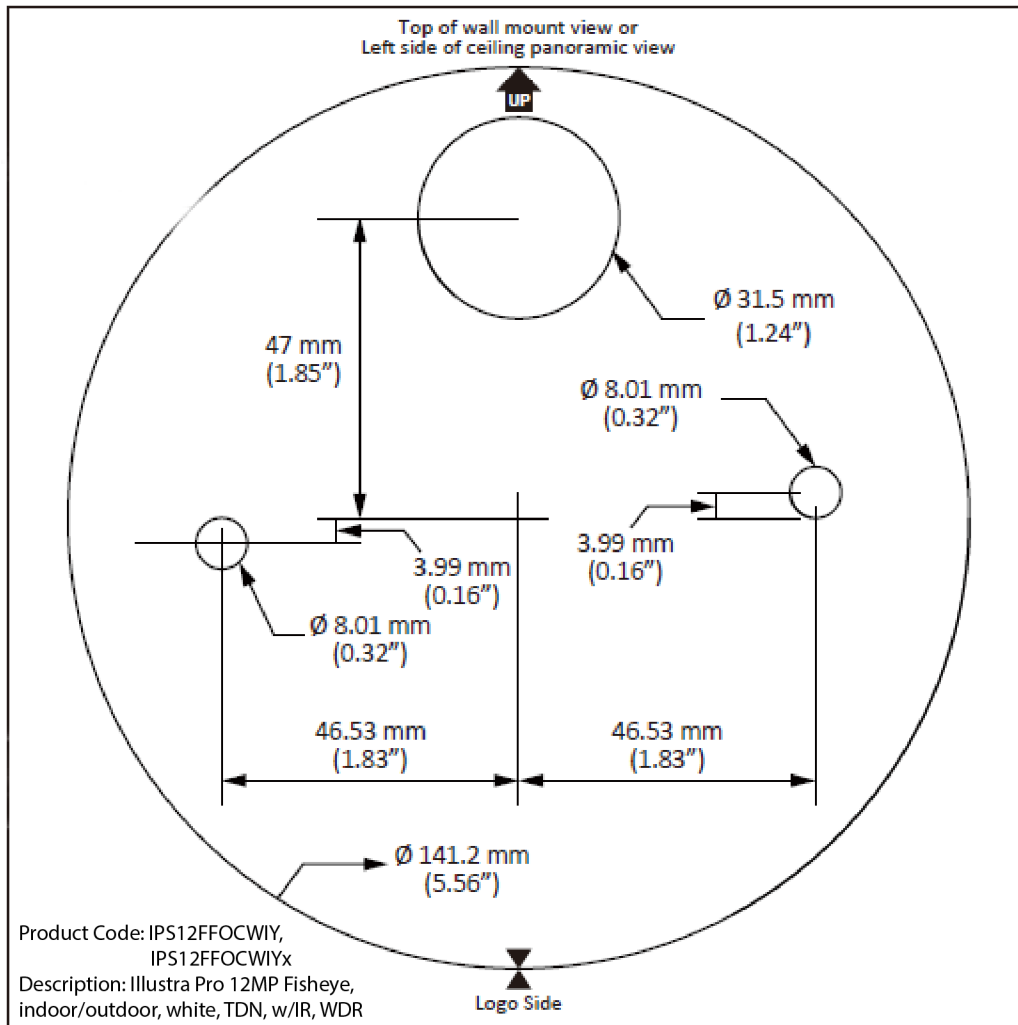

**Figure 3 Mounting Installation Template**

**Note:**

- You can also print and use the template provided on the disk in the box when mounting the camera.
- Size of actual template on disc is 150mm x 150mm.

The camera may be mounted according to your installation needs using the included standoff ring or the included adaptor plate.

You can mount the camera (inside or outside) using the included standoff ring onto the following surfaces:

- a Hard surface
- b Standard double gang box
- c 4s electrical box



**Figure 4 Standoff Ring**

OR

You can mount the camera using the included adaptor plate onto the following surfaces:

- a Standard double gang box (inside)
- b 4s electrical box (inside)
- c Pendant mounts

**Note:**

---

To mount the camera onto pendant mounts, one of the following will be required:

- Illustra Pendant Cap outdoor white, 3/4 "NPT (ADC16DPCAPOW)

OR

- Illustra Pendant Cap outdoor black kit, 3/4" NPT (ADC16DPCAPOB)
- 

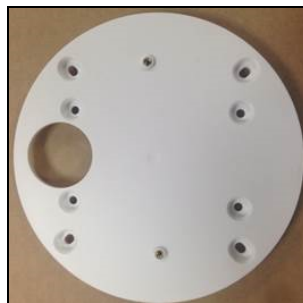

**Figure 5 Adaptor Plate**

## Mounting the camera

Step	Action
1	Place the paper mounting template on the desired installation surface.
2	Drill holes in the correct positions based on the paper mounting template, and insert the plastic anchors into the holes.
3	Connect the required cables to the device.
4	Place the camera body on the mounting surface to match its alignment holes with the corresponding plastic anchors.
5	Tighten the plastic anchors with the screws through the camera's alignment holes.

- End -

## Cable Sealing

Where a conduit is not being used, sealing the cables that are fed through the cable seal is required. This is to protect the camera and maintain camera performance.

### Cable sealing

Step	Action
------	--------

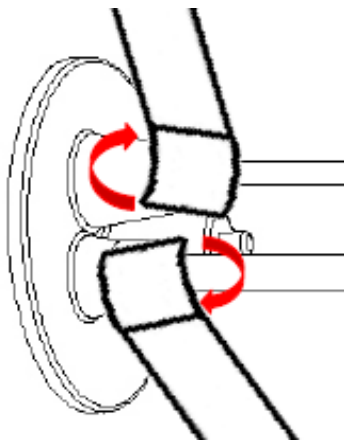
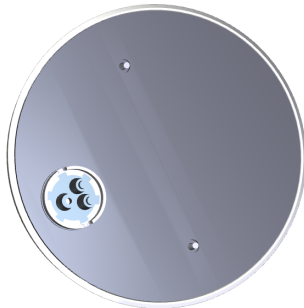

- 1 Turn the camera so that you can see the cable seal on the camera underside. You will see that the cable seal contains three tubes (one open, two closed).
- 2 Insert the cable through the open tube in the cable seal. If you require further cabling, do not cut off the tubes. Instead, snip the tops off the closed tubes using a scissors and feed the cables through the now open tubes, ensuring that there is not excess space around the cables.
- 3 It is required to use the self-fusing tape. Cut the tape off in lengths to wrap around each cable and remove the backing from each side
- 4 Apply the self-fusing tape where each cable enters the tubes making sure it overlaps itself, the tube, and the cable.

# Connecting the Camera

Loosen the security screws by twisting the security torx and open the cover to reach the connectors.

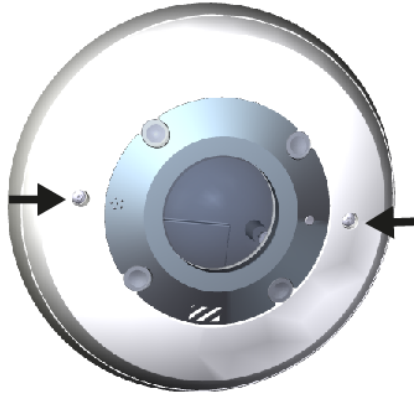

Figure 6 Location of security screws

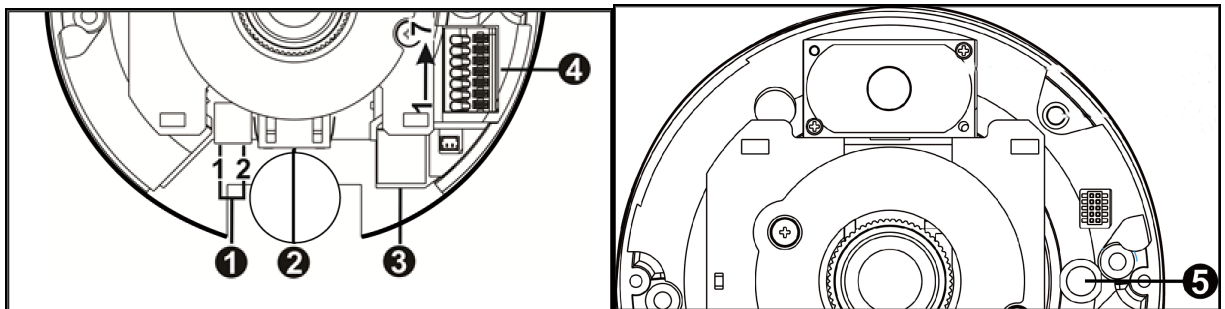

Figure 7 Camera connectors

No.	Connector	Definition
1	1=Power 2=GND	Power Connection
2	RJ-45	For network and PoE connections
3	microSD Card Slot	Insert the microSD card into card slot to store videos and snapshots.
4	Alarm and Audio I/O	Pin 1: Alarm Out + (alarm connection) Pin 2: Alarm Out - (alarm connection) Pin 3: Alarm In + (alarm connection) Pin 4: Alarm In - (alarm connection) Pin 5: GND (Ground connection) Pin 6: Audio Out (two-way audio transmission) Pin 7: Audio In (two-way audio transmission)
5	Reset Button	Press the button for at least 20 seconds to restore the system

# Powering the Camera

---

To power up the camera, connect a DC 12V power adaptor to the power connector of the camera and the power outlet. Alternatively, users can use an Ethernet cable and connect it to the RJ-45 connector of the camera and a Power Sourcing Equipment (PSE) switch / Power over Ethernet (POE) switch.

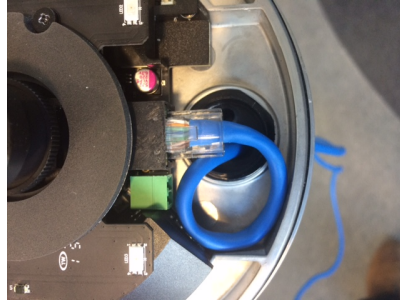

**Figure 8 Cable Connection Point**

## Ethernet Cable Connection

Connect one end of the Ethernet cable to the RJ-45 connector of the camera, and plug the other end of the cable to the network switch or PC. Check the status of the Link Light.

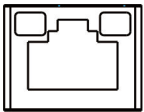

**Green Link Light indicates good network connection.**

**Orange Activity Light flashes for network activity indication.**

---

**Note:**

- If the LEDs are unlit, please check the LAN connection.
  - In some cases, Ethernet crossover cable might be needed when connecting the camera directly to the PC.
-

# Desiccant Bag Installation

You can install the desiccant bag (IP12FEDESIBAG: Pro 12MP Fisheye Desiccant Bag) into the camera by performing the following procedure.

## Installing the desiccant bag

Step	Action
------	--------

- |   |   |
|---|---|
| 1 | Unscrew both top cover screws and remove the top cover. |
|---|---|

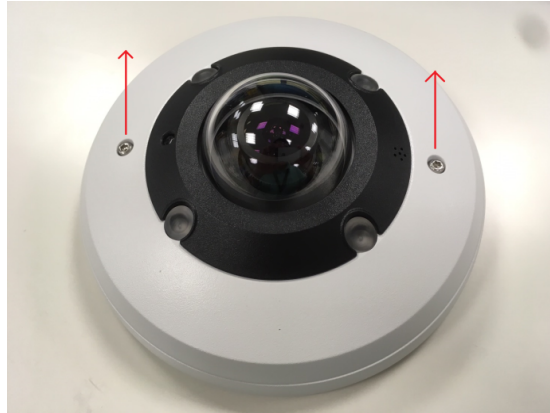

**Figure 9 : Camera top cover and screws**

- |   |   |
|---|---|
| 2 | Remove the desiccant bag from the sealed bag and remove the protective membrane from the double-sided tape. |
|---|---|

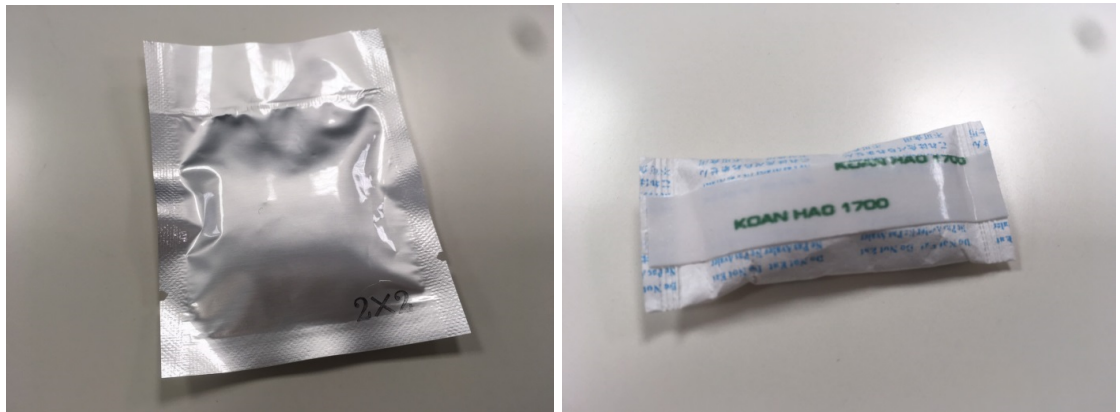

**Figure 10 : Sealed bag (left side) Protective membrane (right side)**

- 3 Fold both ends of the desiccant bag under the bag.



**Figure 11 : Ends folded under the bag**

- 4 Place the desiccant bag in the camera in the location indicated in the red circle in the image below.

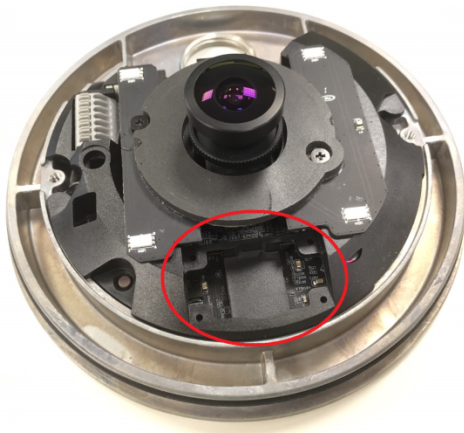

**Figure 12 : Desiccant bag placement location (left side) Desiccant bag in the camera (right side)**

- 5 Place the top cover on the camera and secure both screws.  
**Note:** To help provide maximum protection against condensation you should replace the desiccant bag each time you remove the top cover.
-



**Figure 13 : Top cover securely fitted**

---

- End -

---



# Accessing the Camera for the First Time

---

The camera comes with a web-based setup utility, allowing you to view the video of the camera and configure the camera for optimal use in your environment.

To access the camera's web-based control utility, you need a PC that uses one of the following browsers: Internet Explorer 10 or later, Firefox, Chrome or Safari.

## Accessing the camera for the first time

---

Step	Action
1	Make appropriate network and power connection (typically PoE). The camera will automatically get an IP address if connected to a DHCP network. If DHCP addressing is not available, the camera will use its default fixed address: 192.168.1.168.
2	Find camera(s) on the network using Illustra Connect or another utility; or if using fixed addresses, connect to the camera on its default address.
3	Enter the default ID and password when prompted—ID: admin, Password: admin.
4	Select security type: standard or enhanced.

### Note:

Both security types ask the user to change the username and password, this is advised in standard security mode and required when selecting enhanced security. Creating a new username at this stage automatically replaces the default admin/admin.

---

- End -

---

## Illustra Connect

Illustra Connect is the camera discovery tool created by Tyco Security Products and can be downloaded at [illustracameras.com](http://illustracameras.com)

Connecting to IP cameras and configuring them can be a time-consuming and error-prone process. Typing static IP addresses, or naming cameras without seeing where they are pointed, often results in longer installations. Illustra Connect eliminates all of these issues with a unique feature set that includes a one-touch IP conflict resolver and snapshot tool. Simply bring up all of the cameras out of the box, enter the IP range provided by the customer's IT department and click **OK**.

## Key functions of Illustra Connect

- **Resolve All Conflicts** button instantly alerts you to all IP addresses that are the same and provides a number of options to fix issues
- Reduces installation time by automatically supplying static IP addresses from a configurable range of IP addresses
- Snapshot views of all the cameras
- "Save Device List" allows you to create a .csv' file of all information regarding the camera settings

- Set IP addresses to DHCP
- Configure IP settings and rename cameras
- Upload firmware to individual or selectable group of cameras
- Set date and time or direct the cameras to a specific NTP server
- Assign user name and password
- Uses icons common to victor unified client to display camera status
- Compatible with Illustra IP cameras

## Discovering the Illustra Camera

The following information states how to install and access the camera.

### Illustra Connect

The following information states how to install and access the camera on your network using the Illustra Connect discovery tool.

Illustra Connect enables automatic discovery of compliant devices on IP networks and is the recommended method for installation and detection of the camera on the network.

### Discovering the Illustra Camera using Illustra Connect

Step	Action
1	Connect the camera to the computer or network which will be used for the configuration and power on. The camera will begin its initial boot up sequence which will take approximately 1 to 2 minutes. Out of the box, or when using a DHCP Server the camera will automatically be assigned a Network IP address.
2	Install the Illustra Connect software that is provided with the camera. Refer to the Illustra Connect manual for more information.
3	When the installation is complete, run Illustra Connect. It will search the network and display all devices.
4	Select the camera you wish to configure, locating it by its unique MAC address. Illustra Connect allows basic configuration of the camera. Refer to the Illustra Connect manual for more information.
5	Right-click the camera and select <b>Launch Web GUI Configuration</b> .

- End -

### Configure the Illustra Camera using DHCP Server Logs

Step	Action
1	Connect the camera to the computer or network which will be used for the configuration and power on. The camera will begin its initial boot up sequence which will take approximately 1 to 2 minutes.
2	Out of the box or when using a DHCP Server the camera will automatically be assigned a Network IP Address.
3	View the DHCP Server system logs and make note of the IP address assigned to the camera.

4 Open Microsoft Internet Explorer and enter the URL of the camera as shown in the DHCP Server log.

**Note:**

---

At factory default, after enabling DHCP manually or if it is the first time the camera has been configured; the camera will reboot using the Failover IP of the last known static IP address until a DHCP address request is authorised by the DHCP server. The DHCP requests will remain active unless cameras are changed to Static IP.

---

- End -

---

## Configuring the Illustra Camera using a Static IP Address

The following information states how to install the camera on your network when no DHCP Server is available. In this situation the camera will be assigned a Static IP Address.

Connect the camera to the computer or network which will be used for the configuration and power on.

**Note:**

---

- We recommend that once you are logged into the Web Configuration pages you change the Static IP Address of the camera so that conflicts can be avoided when using the same Static IP Address to setup additional cameras.
  - In a situation where IP address conflicts arise, Illustra Connect can be used to discover the device.
-

# Physical Reset of the Camera

---

It is possible to perform a physical reset to factory defaults using the reset button located on the underside of the camera.

## Resetting the Camera to Factory Default Settings Using the Reset Button

The reset button can be used to restore the camera to the factory default settings.

**Note:**

---

It is not possible to retain network settings, presets, patterns or sequences when using this procedure. If you need to maintain these settings it is recommended to reset the camera using the GUI.

---

## Reset the Camera to Factory Default Settings Using the Reset Button

---

Step	Action
------	--------

---

- 1 Locate the reset button on the underside of the camera.
- 2 Press and hold the reset button for at least 20 seconds.
- 3 Release the reset button.

It may take up to 2 minutes for the camera to restart.

**Note:**

---

It is also possible to reset the camera through the **Maintenance** tab located in the **System** menu.

---

---

- End -

---

# Technical Specifications

This section provides information on the technical, environmental and operating specifications for the Illustra Pro Fisheye Camera.

Illustra Fisheye Product Description	Product Code
Illustra Pro 12 MP Fisheye, indoor/outdoor, white TDN w/IR, WDR	IPS12FFOCWIY/ IPS12FFOCWIYx

## Technical Specifications

Specification	Detail
Privacy Zones	5
Language Selection	English (default), Arabic, Czech, Danish, German, French, Spanish, Italian, Korean, Japanese, Dutch, Polish, Portuguese (Brazilian), Turkish, Chinese Traditional, Chinese Simplified, Russian.
Motion Detection	Yes
Browser Compatibility	IE 10-11, Safari, Firefox, and Chrome.

## MJPEG/JPEG Compressor Key Functionality

The JPEG codec supports the JPEG baseline DCT encoding process with the following additional configuration option:

- Quality: 1-100

## H.264 Compressor Key Functionality

The H.264 codec supports the JPEG baseline DCT encoding process with the following additional configuration options:

Category	Details
GOP Length	1-255
Rate Control	CBR VBR CVBR
Bit Rate (CBR)	Selectable 64-20480Kbps
Quality (VBR)	Highest, High, Medium, Low, Lowest

Category	Details
Bit Rate (CVBR)	Selectable 64-20480Kbps OR Highest, High, Medium, Low, Lowest

## Resolution

Client Dewarp Mode					
Image Source	Symbol	Max fps	1st Stream	2nd Stream	3rd Stream
			H.264 or MJPEG	H.264 or MJPEG	MJPEG (locked)
Fisheye		15 fps	(2992x2992) 1:1 (2048x2048) 1:1 (1408x1408) 1:1 (1072x1072) 1:1 (960x960) 1:1 (720x720) 1:1 (640x640) 1:1	(1072x1072) 1:1 (960x960) 1:1 (720x720) 1:1 (640x640) 1:1 (480x480) 1:1 (384x384) 1:1	(720x720) 1:1 (640x640) 1:1 (480x480) 1:1 (384x384) 1:1

### Note:

- When resolution width or height larger than 2040 (resolution marked red), MJPEG can't be set (there is no 2048x2048 MJPEG, but you can set 2048x2048 H.264)
- Each stream can have an independent frame rate (fps), but they must be equal to or less than the max fps listed
- Stream resolutions are independent; each stream can operate at any resolution in the column below
- On stream 1, 640x640, and on streams 2 and 3, 352x352 are the lowest resolutions Fisheye view can be operated with when using Edge Dewarp
- Out of the box, the default mode is Client Dewarp
- You can view dewarped view in Client mode using Internet Explorer Viewer, which provides a GUI stream dewarping feature
- The following mount image source combinations are possible:









#### Ceiling mount view modes:

- Fisheye  Ceiling panorama
- Quad Active Image (4x ePTZ)  Active Image

#### Wall mount view modes:

- Fisheye  Wall panorama
- Combi (panorama + 2 ePTZ)  Active Image

- Dewarping will apply to only GUI stream and does not affect RTSP or Server connected stream

Edge Dewarp					
			1st Stream	2nd Stream	3rd Stream
Image Source	Symbol	Max fps	H.264 or MJPEG	H.264 or MJPEG	H.264 or MJPEG
Ceiling Panoramic Wall Panoramic	 	15	(2688x1512) 16:9 (1920x1080) 1080p 16:9 (1664x936) 16:9 (1280x720) 720p 16:9 (1024x576) PAL 16:9 (960x544) 16:9 (640x360) nHD 16:9 (384x216) 16:9	(960x544) 16:9 (640x360) nHD 16:9 (480x360) 480 4:3 (384x288) 4:3 (384x216) 16:9	(960x544) 16:9 (640x360) nHD 16:9 (480x360) 480 4:3 (384x288) 4:3 (384x216) 16:9
4xActive Image (4 ePTZ) ceiling mount Combi image (180 +2 ePTZ) wall mount	 	20	(1920x1080) 1080p 16:9 (1664x936) 16:9 (1280x720) 720p 16:9 (1024x576) PAL 16:9 (960x544) 16:9 (640x360) nHD 16:9 (384x216) 16:9	(960x544) 16:9 (640x360) nHD 16:9 (480x360) 480 ) 4:3 (384x288) 4:3 (384x216) 16:9	(960x544) 16:9 (640x360) nHD 16:9 (480x360) 480 4:3 (384x288) 4:3 (384x216) 16:9
Active Image (ePTZ)		20	(960x544) 16:9 (640x360) nHD 16:9 (384x216) 16:9	(960x544) 16:9 (640x360) nHD 16:9 (480x360) 480 4:3 (384x288) 4:3 (384x216) 16:9	(960x544) 16:9 (640x360) nHD 16:9 (480x360) 480 4:3 (384x216) 16:9
Fisheye		15	(2048x2048) 1:1	(1408x1408) 1:1 (1072x1072) 1:1 (960x960) 1:1 (720x720) 1:1 (640x640) 1:1 (480x480) 1:1 (352x352) 1:1	(720x720) 1:1 (640x640) 1:1 (480x480) 1:1 (352x352) 1:1
Fisheye		20	(1408x1408) 1:1 (1072x1072) 1:1 (960x960) 1:1	(1408x1408) 1:1 (1072x1072) 1:1 (960x960) 1:1 (720x720) 1:1 (640x640) 1:1 (480x480) 1:1 (352x352) 1:1	(720x720) 1:1 (640x640) 1:1 (480x480) 1:1 (352x352) 1:1
Fisheye		30	(720x720) 1:1 (640x640) 1:1	(1408x1408) 1:1 (1072x1072) 1:1 (960x960) 1:1 (720x720) 1:1 (640x640) 1:1 (480x480) 1:1 (352x352) 1:1	(720x720) 1:1 (640x640) 1:1 (480x480) 1:1 (352x352) 1:1

### Note:

---

- When resolution width or height is larger than 2040 (resolution marked **red**), MJPEG codec cannot be set
- Streams 1, 2, and 3 fps can be set from 1 to maximum fps. Maximum fps is dependent on the resolution of stream 1
- Each stream can have an independent frame rate (fps), but they must be equal to or less than the max fps listed
- 640x640 on stream 1 and 352x352 on streams 2 and 3 are the lowest resolution fisheye possible in Edge Dewarp
- The image source set on stream 1 is replicated on stream 2 and 3
- Once image source, resolution, and max fps is selected for stream 1, possible resolution selections for streams 2 and 3 will update accordingly
- Changing image source will automatically reset all stream configurations to their default values.
- The following mount image source combinations are possible:

**ceiling mount view modes:**  Ceiling panorama  Quad Active Image (4x ePTZ)  Active Image

**wall mount view modes:**  Wall panorama  Combi (panorama + 2 ePTZ)  Active Image

---

## Base Protocol and Underlying Layers

- The camera is an IP camera compatible with TCP/IP protocol.
- The camera supports both IPv4 and IPv6, running either in single stack mode or dual stack mode (supporting both IP versions at the same time).
- TCP is used for two way communication and UDP will be used for broadcasting protocols.
- HTTP is used for the ONVIF protocol as transport mechanism for SOAP calls.
- FTP can be used to push alarm buffer video clips to a specified remote FTP server. The camera can use anonymous FTP or a specified username and password. There is no incoming FTP service.

## Network Access Configuration

- **DHCP (Dynamic Host Configuration Protocol)** will be enabled by default on the camera. During the boot process, the camera will attempt to acquire a network address via DHCP. The DHCP client will be configured to do 3 attempts with a 20 second timeout.
- **Static IP** can be used if the camera cannot be found on the network using DHCP. In this mode, the static IP address, subnet mask, default router and primary and secondary DNS server can be configured. This will be used by the camera when turned on. It is possible to assign a static IPv4 address while still allowing the IPv6 addressing to be Link Local (automatically assigned).
- **Dynamic DNS or DDNS Dynamic Domain Name System** is supported for updating, in real time a changing IP address on the Internet to provide a persistent domain name for a resource that may change location on the



network. RFC 2136 Dynamic Updates in the Domain Name System. In this situation the camera talks only to the DHCP server and the DHCP server is responsible for updating the DNS server. The camera sends its hostname to the DHCP server when requesting a new lease and the DHCP server updates the DNS records accordingly. This is suitable for an intranet style configuration where there is an internal DHCP and DNS service and the user wants only to access their camera within their own network.

By default, when making a DHCP request the camera will transmit its hostname as part of the DHCP request. This option is not user configurable. The camera's hostname matches the configurable parameter "camera name" on the web GUI. Any DHCP request will contain the camera's hostname for use of the DHCP server to forward to an appropriate DNS server.

## Network Name Resolution

The camera uses DNS protocol to resolve network names. DNS server address will be acquired via DHCP or manually set for static IP configuration. Camera configuration supports symbolic names for all remote end-points (except DNS servers) but in this mode will depend on a working and correctly configured remote DNS server.

## Email

The camera can send email alerts via SMTP to one specified mailbox using a specified SMTP server. Support is provided for basic authenticated SMTP using username and password for login on the SMTP server.

## Time Synchronization and Configuration

The camera supports NTP for time synchronization. The NTP server will have to be configured by the user. Alternatively, time can be manually configured via the Web GUI or ONVIF. Time synchronization has 1/day poll rate.

## Authentication and Security

- HTTPS (HTTP over TLS) is used for the Web GUI. HTTP connections to the camera IP will automatically be redirected to the HTTPS login page.
- The camera will automatically create a SSL certificate file to use for HTTPS. It is possible to upload a custom SSL certificate if validation is desired.
- The ONVIF service uses WS-Security Username Token Digest.

## Firewall

The camera will provide a firewall, which is disabled by default. The firewall will be able to block ICMP and allow RP filtering and SYN Cookie Verification. The firewall will offer the ability to block selected IP or MAC addresses and allow access exclusively to selected IP and MAC addresses.

Note: Using the “Deny all” mode, could result in a mis-configuration and require resetting the camera via the physical reset button.

## Illustra API Version

AD iAP13

## Discovery

The product supports WS-Discovery and UPnP discovery.

A copy of illustra Connect is supplied with the camera, this is a MS-Windows based discovery application, which will allow discovering any illustra camera on a network.

For each camera found on the network, the discovery tools will report:

- Serial number.
- Model Name.
- Product Code (Hardware ID).
- MAC address.
- Current IP address.
- Firmware version.

This tool will allow configuration of:

- DHCP.
- Static IP configuration.
- Select a number of cameras and push a firmware update via ONVIF.
- Bulk configuration of specific setting via iAP13.

## UPnP Discovery

UPnP (Universal Plug and Play) broadcasts information about the camera to other devices on the network.

The information broadcasted about the camera includes:

- Device Name: <Product Code><Serial Number>
- Manufacturer and manufacturer URL
- Model (product code) and model URL ( same as manufacturer URL)
- Device webpage (camera homepage)
- Serial number
- MAC address
- Unique Identifier: uuid<unique id for that camera type><serial number
- IP address

**Supported:**

- Windows XP, Windows 7, Windows 8 and Windows 10
- HTTP and HTTPS

**Unsupported:**

- Video Streaming
- Audio Streaming
- API command to enable and disable UPnP feature

## ONVIF Video and Control Interface

The primary video and control interface to the camera is the Open Network Video Interface Forum global standard for the interface of network video products. This uses SOAP over HTTP. The camera provides ONVIF for integration to internal and external systems.

## Interface Technical Specifications

Category	Details
Description Language	WSDL
Web Services Specification	DPWS
Web Services Tool Kit	WS4D
Web Services Protocol	SOAP
Message Format	XML
Discovery	WS Discovery, ONVIF discovery, Illustra Connect discovery, uPnP discovery
Security	WS-Security
Video Transport	RTP/RTSP
Audio Transport	RTP/RTSP
Event Handling (alarms)	<ul style="list-style-type: none"> <li>• WS-Eventing</li> <li>• WS-Base Notification</li> <li>• WS-Topics</li> </ul>
Service Connection	WS-Addressing
Security Permissions	WS-Policy
Data Object Exchange Specification	WS-Transfer

## ONVIF Functions Supported

The following ONVIF functions are supported on the camera:

- Quality priority and maximum AGC settings adjustable via user GUI, IAP13, or and ONVIF
- Manual Red and Blue adjustments available via user GUI, IAPI3, and ONVIF
- The product can interwork with Genetec via ONVIF
- ONVIF GetSnapshotUri command
- Auto-discovery
- Ws-discovery
- Automatic addressing
- SetDiscoveryMode
- Default and Reset functions

## microSD Card

External access is provided for a microSD for video alarm storage and audio output pre-recorded clips.

The following microSD cards can be used with the camera:

- 2GB, 8GB, 16GB AND 32GB with class 2 or 10 support
- 64GB with class 10 support



### Caution

---

If you wish to use the SD card, it must be present when the camera boots up or it will require mounting manually via the WebGUI.

## Environmental

The product is designed to meet the following environmental conditions:

- PoE power (802.3af, 15.4w) with an operating temperature range of -30°C to +50°C and a cold start temperature range of -25°C to +50°C.
- IP-66 water intrusion rating.
- DC12.

## Power

Usable with PoE and DC12 sources with up to 100m (300 feet) of cable; with compliance verification including power over Ethernet compliant to POE IEEE 802.3afTM and power over Ethernet Plus compliant to POE IEEE 802.3atTM.

Power consumption is capped at 12.95Watts.

## Regulatory Compliance

The Illustra Pro Fisheye Camera meets the following regulatory requirements:

	USA (FCC): CFR 47 Part 15 Canada: ICES-003/NMB-003 Issue 5 European Union: EN 55022:2010 European Union: EN 61000-3-2:2006/A2:2009 European Union: EN 61000-3-3:2008 Australia/New Zealand: AS/NZS CISPR 22:2009
	EN50130-4:2011
	CB Scheme: IEC 60950-1:2005/A1:2009 European Union: EN 60950-1:2006/ A11:2009 + A1:2010 + A12:2011 USA: UL 60950-1:2007/A1:2011 d. Canada: CAN/CSA-C22.2 NO. 60950-1A-07/A1:2011 Outdoor Housing: United States: UL 60950-22 Canada: CAN/CSA-C22.2 NO. 60950-22-07 Global: IEC 60529 Recessed housing: United States: UL 2043
Vandal Resistant Rating	IK10

# Appendix A: Camera Defaults for Fisheye Camera

Image Settings			
Video Codec	Primary Stream	Codec	H.264
		Resolution	2992x2992 max
		Frame Rate	15 fps max
		GOP Length	15fps
		Rate Control	CVBR High
		Bit Rate	8192 Kbps
		Max Bit Rate (CVBR)	8192 Kbps
		Image quality (QP Settings)	High
	Secondary Stream	Codec	H264
		Resolution	1072x1072 max
		Frame Rate	30 fps max
		GOP Length	15fps
		Rate Control	CVBR
Quality		High 4096 Kbps	
Third Stream	Codec	MJPEG	
	Resolution	720x720 max	
	Quality	70	
	Frame Rate	7fps	
Audio	Audio In	Codec	G.711
		Audio In Enable	OFF
		Input Volume	10dB
	Audio out	Output Enable	off
		Output Volume	15
Privacy Zone		Privacy Zone	Disabled

Network Settings		
IP & Ethernet	Camera name	Same as camera friendly name
User management	Default account	Authority: administrator
		Username/Password: admin/admin

Network Settings		
Language	Basic Settings	English
IP Settings	DHCP	Enabled
	IP v4	Always on
	IPv6	Enabled
	IP v6 address	Camera specific
	IP v4 address	192.168.1.168
	IP v4 Subnet Mask	255.255.255.0
	Default Gateway	192.168.1.254
	DNS	0.0.0.0
	HTTP Port	80
FTP	Enabled	Off
	FTP Server IP Address	0.0.0.0
	FTP Server Port	21
	Username	Null
	Password	Null
	File Upload Path	Default folder Null
SNMP	SNMP Server IP Address	0.0.0.0
	SNMP Port #	161
	SNMP TRAPS Port #	160
SMTP	SMTP Server Requires Authorization	Disabled
	SMTP Server IP Address	0.0.0.0
	Server Port	25
	User Name	Null
	User Authentication	off
	Password	Null
	Sender	Null
	Receiver	Null
Date and Time	NTP Server IP Address	pool.ntp.org
	Time Zone	GMT-5:00 Eastern Time (US & Canada)
	Date and Time	Manual
	NTP	Off
RTSP	Primary Video Stream Port	rtsp://CAMERAIP/videoStreamId=1&audioStreamID=1

Network Settings		
	Secondary Video Stream Port	rtsp://CAMERAIP/VideoStreamId=2&audioStreamId=2
	Tertiary Video Stream Port	rtsp://CAMERAIP//videoStreamId=3&audioStreamId=1
ONVIF	Discovery via ONVIF	Enabled
	User Authentication	Enabled
Dynamic DNS	off	
Address Filtering	off	

Event Settings		
Motion Detection	Profile	1
	Enable Motion detection	Off
	Sensitivity	High
	Size	20
	Hysteresis	10
	Action	None

Picture Settings		
White Balance	Auto White Balance	Auto
	Red	50%
	Blue	50%
Picture Adjustment	Brightness	50%
	Sharpness	18%
	Contrast	50 %
	Saturation	25%
WDR		Disabled
IR/DayNight	IR Mode	Enabled
	Day Night Mode	Auto Mid
Dewarp Method		Client
Dewarp Mount		Ceiling

PTZ Settings		
Scan Limits	Left	0
	Right	359