

# ADC16P2x2IW Ceiling Mount

## Installation Guide

**Regulatory Compliance: Safety UL60950-1**

The ADC16P2x2IW ceiling mount is used to mount the following cameras in a 2x2 suspended ceiling:

- Illustra Pro PTZ recessed flush mount
- Illustra 625PTZ recessed flush mount
- SpeedDome Optima camera

This guide explains how to assemble and install this mounting structure.

### Parts Supplied

Plate 2x2 Mount	0500-9314-01
Galvanized Wire Hanger	2898-0007-01
T Bar Ceiling Kit	0351-1673-01
Optima 2x2 Install Kit	0351-1687-01

## Installing the Ceiling Mount

**Note:** If placing the ceiling mount into a 2 x 4 foot opening, use install kit 0351-1673-01. See instructions supplied with the kit.

1. Steps a through f refer to **Figure 1**.
  - a. Remove the ceiling tile to create an opening where the mounting plate for the ceiling mount will go. Also remove adjacent tiles on both sides of the opening to facilitate access to cables.
  - b. Thread each of four hanging wires around a roof structure nearest the four corners of the opening such as red iron or I-beams (DO NOT attach to pipes or conduit). Twist each wire around itself at least four times to secure it to the roof structure.
  - c. Remove four turnbuckles from the kit and extend the hook and eye of each one all the way.
  - d. Insert the hook of the turnbuckle into each of four holes in the mounting plate. Using pliers, crimp the hook to affix the turnbuckle to the plate.
  - e. Tilt the mounting plate to get it above the opening, then drop it in place.
  - f. Straighten each hanging wire, then thread it through the eye of the turnbuckle closest to it and twist it around itself at least four times.

**Figure 1.**

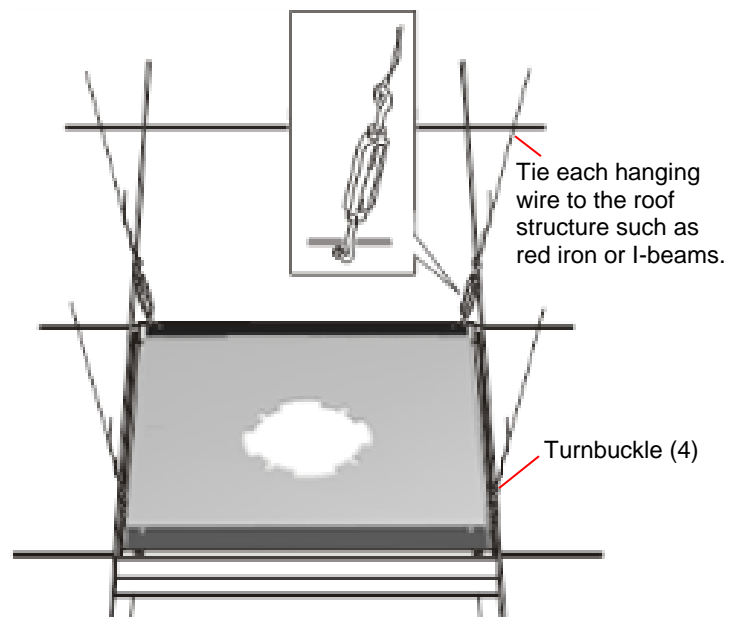

©2015 Tyco Security Products. All rights reserved.

## Inserting the Illustra P Illustra Pro PTZ Cameras

1. Ensure the orientation of the camera is aligned as shown in **Figure 2a** where the cutouts of in the ceiling plate are aligned with the cutouts in the indoor flush mount housing.
2. Once in place, turn the locking screws clockwise to seat the “swing out” mounting clips tightly against the ceiling to secure as seen in **Figure 2b**.
3. Using the safety wires, attach the housing to a strong structural ceiling and twist the wire around itself four times to secure. Ensure that the wire is taut as shown in **Figure 3**.
4. Refer to **8200-1199-04 A0 Quick Reference Guide Illustra Pro PTZ Recessed Indoor Flush Mount Housing** for guidance on inserting this camera.

Figure 2a

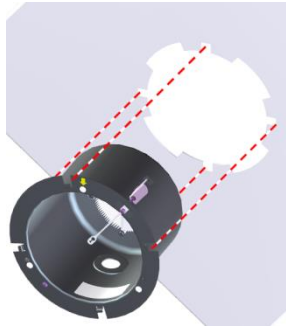

Figure 2b

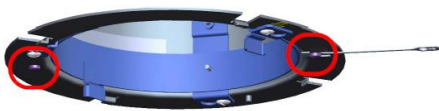
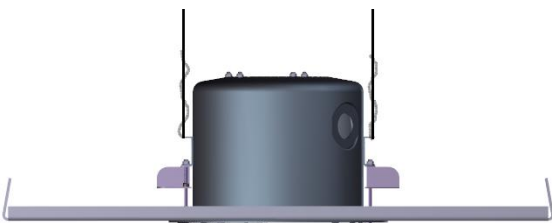

Figure 3



## Inserting the SpeedDome Optima Camera in a 2x2 suspended ceiling

1. For ease of installation, turn each of the locking screws in the dome housing counterclockwise to raise “swing out” mounting clips so they accommodate the thickness of the mounting plate as shown in **Figure 3**.

Figure 3

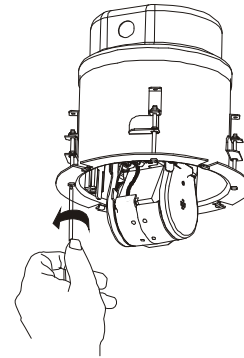

2. Insert the dome housing into the hole in the mounting plate as shown in **Figure 4**.

Figure 4.

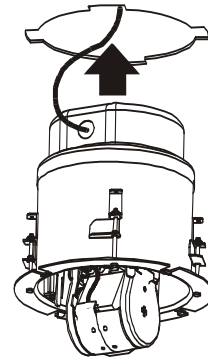

3. Turn each of the locking screws clockwise to fully extend the “swing out” mounting clips and to seat them tightly against the top surface of the mounting plate as shown in **Figure 5**.

Figure 5.

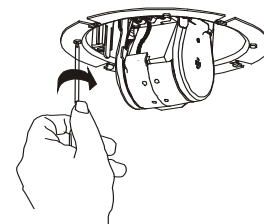

4. As shown in **Figure 6** attach the dome housing to a strong structural ceiling member as follows:
  - a. Attach an S-hook to the safety chain (supplied with Optima housing kit) and attach its other end to the dome where shown. Close the ends of the S-hook.
  - b. Wrap the other end of the chain around a structural ceiling member immediately above the dome and pull the chain taut (see WARNING below).
  - c. Attach the end of the chain to itself using another S-hook. Close the ends of the S-hook.



**WARNING!** Keep the chain taut as possible. Close both ends of each S-hook. Do not secure to sprinkler head of fire control system.

Once tightened, the chain should support the ceiling mount, not the ceiling T-bars.

**Figure 6**

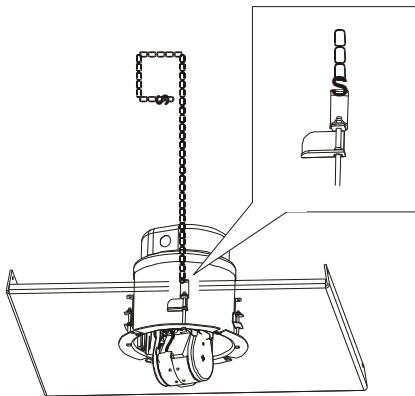

5. Referring back to **Figure 1**, turn screws of each turnbuckle to tighten hanging wires. Tighten until the mounting plate slightly touches T-bars on all four sides, but not so much that a gap shows between the plate and the T-bar. Hanging wires should be taut.



**WARNING!** Adjust turnbuckles to keep hanging wire taut! Once tightened, hanging wires should support only the pendant mount, not the ceiling T-bars. Ensure structural members can support the mount.

6. Use the four clips supplied to secure the mounting plate to the T-bars. Center one clip on each side of the plate.
7. Attach the bubble as follows:
  - a. As shown in **Figure 7**, place the large hole at the end of the lanyard over the screw head of the bubble. Loop the lanyard to the inside of the housing and pull its end to snap it in place.

**Figure 7**

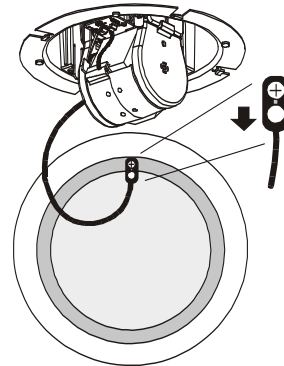

- b. Center the bubble over the dome housing and align its tabs with the mating tabs in the housing as shown in **Figure 8**.

**Figure 8**

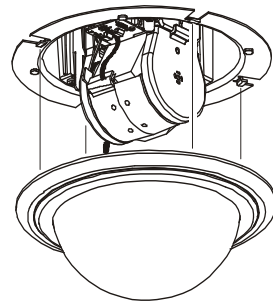

- c. Turn the bubble clockwise until it catches the tabs and stops as shown in **Figure 9**.

**Figure 9**

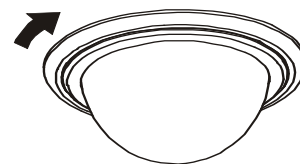

## Declarations

Thank you for using Tyco Security Products. We support our products through an extensive and worldwide network of dealers. The dealer, through whom you originally purchased this product, is your point of contact if you have a need for service or support. Our dealers are fully empowered to provide the very best in customer service and support. Dealers should contact Tyco Security Products at (800) 507-6268 or (561) 912-6259 or on the web at [www.Illustracameras.com](http://www.Illustracameras.com).

**WARRANTY DISCLAIMER:** Sensormatic Electronics Corporation makes no representation or warranty with respect to the contents hereof and specifically disclaims any implied warranties of merchantability or fitness for any particular purpose.

**NOTICE:** The information in this manual was current when published. The manufacturer reserves the right to revise and improve its products. All specifications are therefore subject to change without notice.

**LIMITED RIGHTS NOTICE:** For units of the Department of Defense, all documentation and manuals were developed at private expense and no part of it was developed using Government Funds. The restrictions governing the use and disclosure of technical data marked with this legend are set forth in the definition of "limited rights" in paragraph (a) (15) of the clause of DFARS 252.227.7013. Unpublished - rights reserved under the Copyright Laws of the United States.

**TRADEMARK NOTICE:** The trademarks, logos, and service marks displayed on this document are registered in the United States [or other countries]. Any misuse of the trademarks is strictly prohibited and Tyco Security Products will aggressively enforce its intellectual property rights to the fullest extent of the law, including pursuit of criminal prosecution wherever necessary. All trademarks not owned by Tyco Security Products are the property of their respective owners, and are used with permission or allowed under applicable laws.

Product offerings and specifications are subject to change without notice. Actual products may vary from photos. Not all products include all features. Availability varies by region; contact your sales representative.

**COPYRIGHT:** Under copyright laws, the contents of this manual may not be copied, photocopied, reproduced, translated or reduced to any electronic medium or machine-readable form, in whole or in part, without prior written consent of ©2015 Tyco Security Products. All rights reserved.

Tyco Security Products  
6600 Congress Avenue  
Boca Raton, FL 33487 U.S.A.

[www.Illustracameras.com](http://www.Illustracameras.com)