

3610-0607-67A0

**tyco**

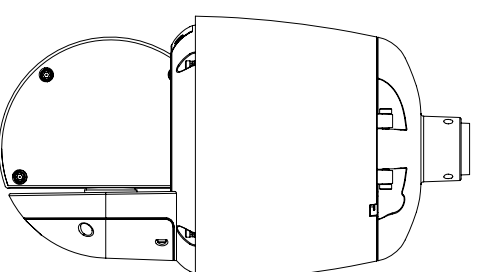
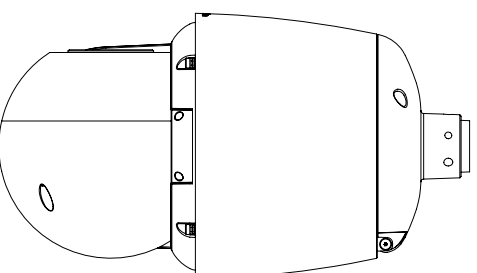
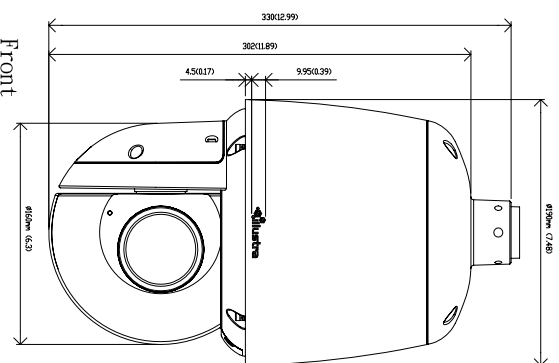
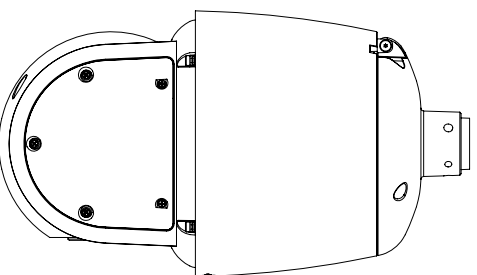
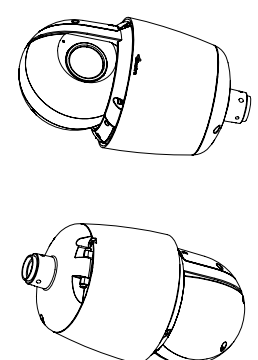
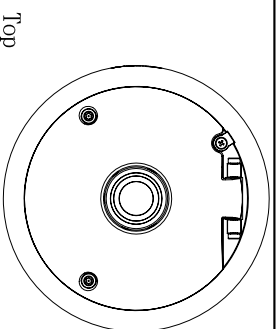

Left side

Front

Right side

Back

Unit : mm(inch)

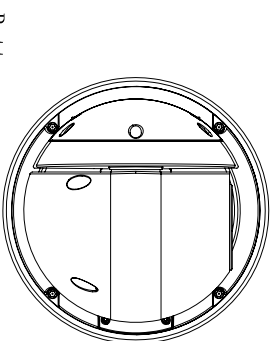

Bottom

Part	Material	Color
Top case	Aluminum	RAL9003
Body(out)	Aluminum	RAL9003
Body(in)	Aluminum	RAL9017
Base	Aluminum	RAL9017
Base(ball)	Aluminum	RAL9017
Bottom case	Aluminum	RAL9017
SD cover	Aluminum	RAL9017
Side cover	Plastic	Black
IR cover	Plastic	Black
Lens cover	Plastic	Transparent

**Illustra Flex 2MP Indoor & Outdoor IR PTZ 30X**

General Notes

No. Revision/Issue Date

**tyco**

IFS02P60NWIT  
IFS02P61NWIT

Project: \_\_\_\_\_  
Date: \_\_\_\_\_  
Scale: \_\_\_\_\_